

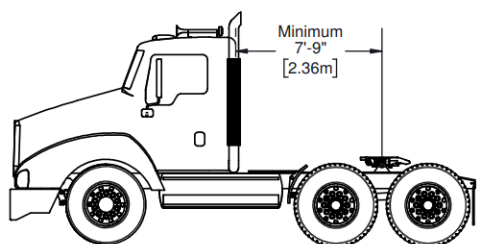

RENTAL DIVISION - DIVISION LOCATION

# SAM555

## TECHNICAL DRAWINGS

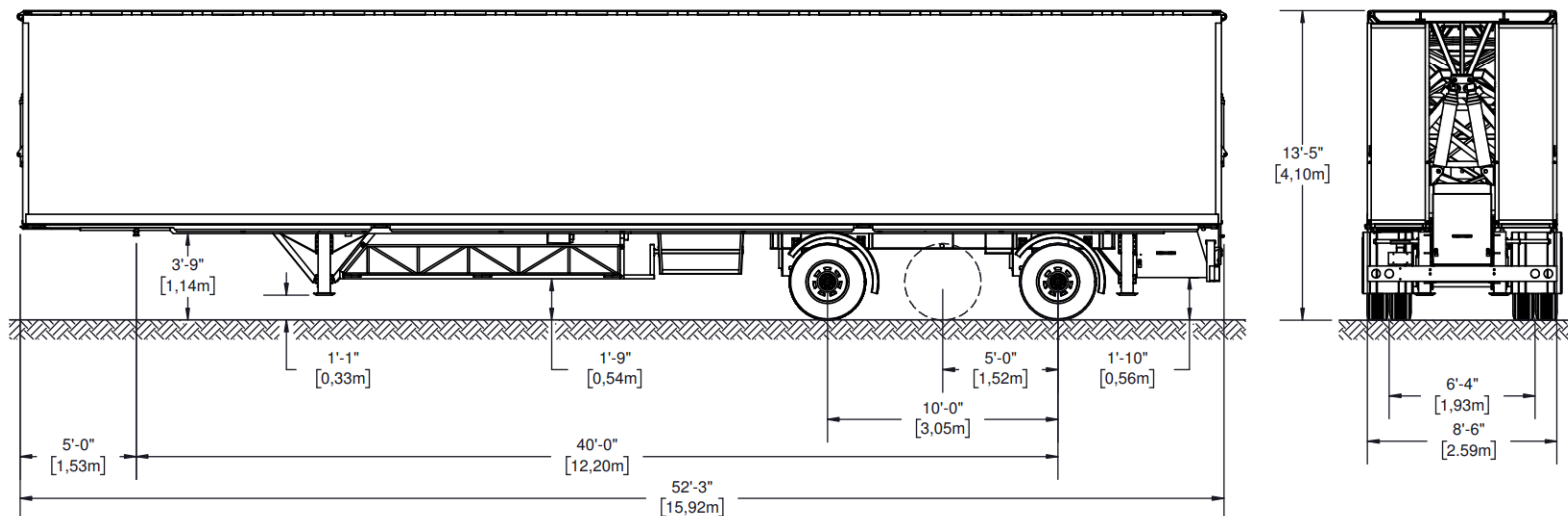

Mass SAM555	Unladen		Standard Equipment		Maximum Capacity	
	Lbs	Kg	Lbs	Kg	Lbs	Kg
Total Mass	50229	22784	60000	27216	67000	30391
Mass on Axle	32421	14706	40000	18144	43000	19505
Mass on Hitch	17808	8078	20001	9072	24000	10886

Drawings may show stage equipped with optional accessories. May be sold separately.

© 2022 - All rights reserved, Stageline Mobile Stage Inc. Any and all forms of adaptation or reproduction of this document including the plans and drawings, in whole or in part, are strictly forbidden without the written authorisation of Stageline Mobile Stage Inc. Mass may vary depending on options. Technical specifications may change without notice. Stage specifications are subject to change without notice. Figures are nominal.

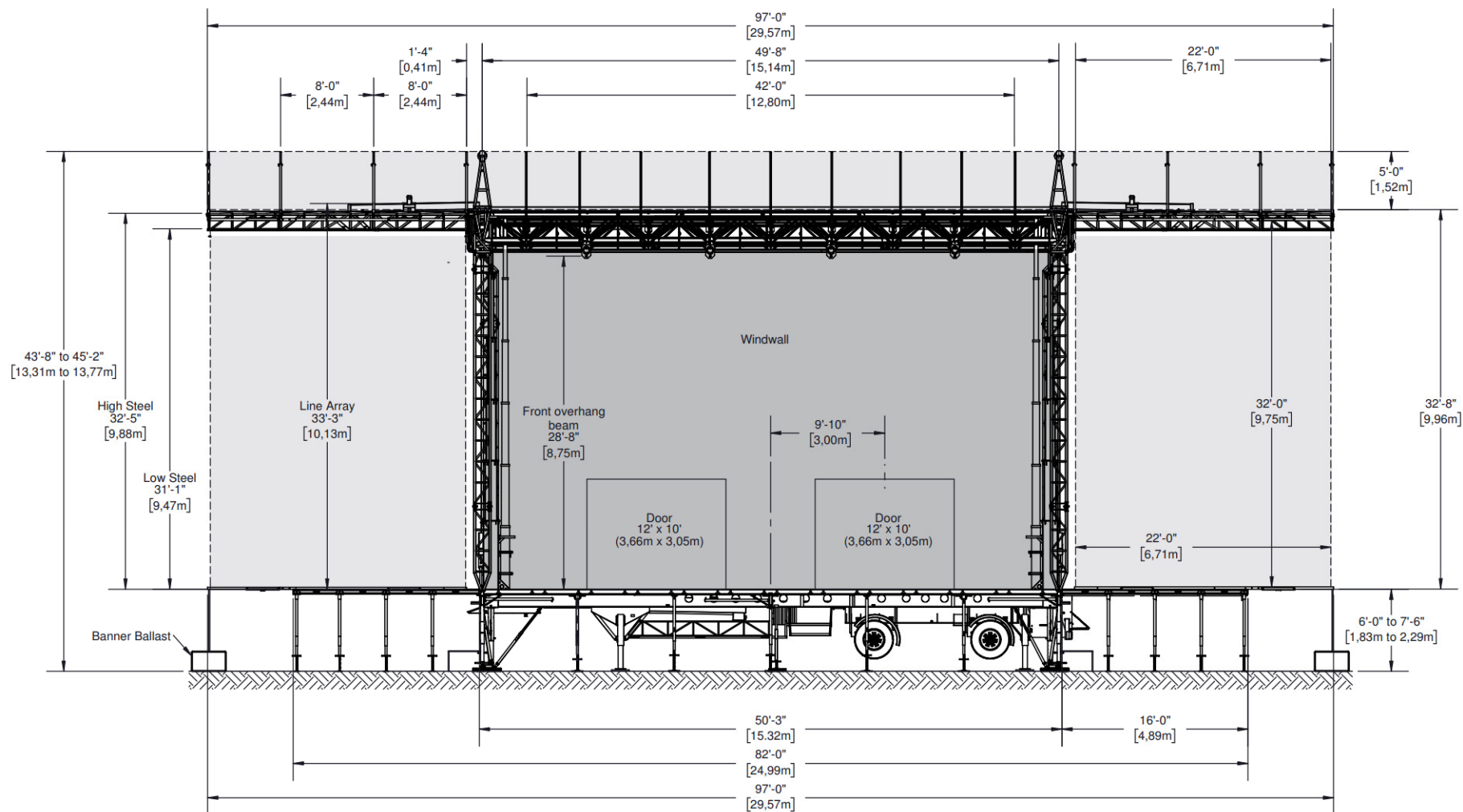

- WINDWALL
- BANNER (For dimensions, please refer to Banner Book)

Drawings may show stage equipped with optional accessories. May be sold separately.

© 2022 - All rights reserved, Stageline Mobile Stage Inc. Any and all forms of adaptation or reproduction of this document including the plans and drawings, in whole or in part, are strictly forbidden without the written authorisation of Stageline Mobile Stage Inc. Mass may vary depending on options. Technical specifications may change without notice. Stage specifications are subject to change without notice. Figures are nominal.

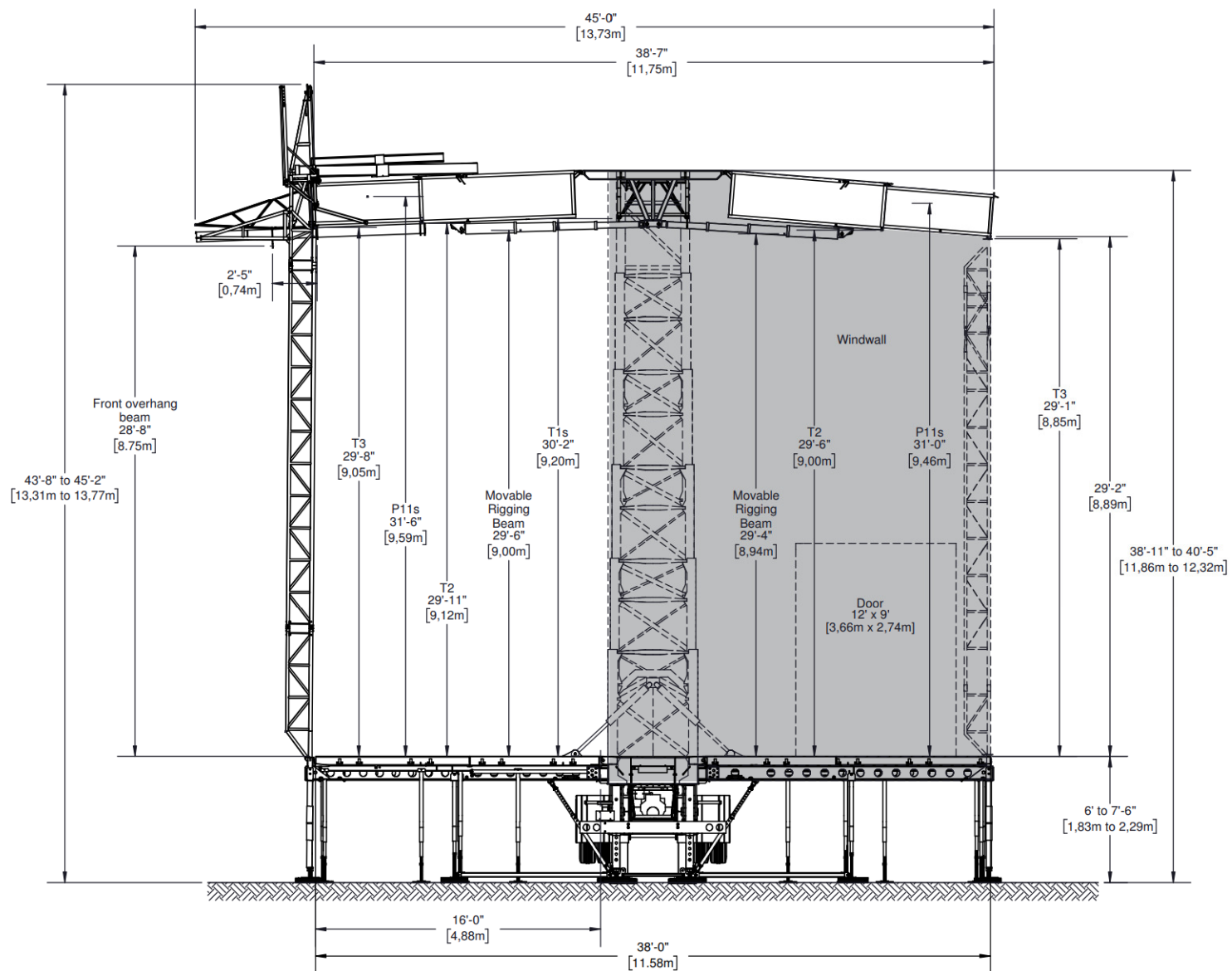

WINDWALL

Drawings may show stage equipped with optional accessories. May be sold separately.

© 2022 - All rights reserved, Stageline Mobile Stage Inc. Any and all forms of adaptation or reproduction of this document including the plans and drawings, in whole or in part, are strictly forbidden without the written authorisation of Stageline Mobile Stage Inc. Mass may vary depending on options. Technical specifications may change without notice. Stage specifications are subject to change without notice. Figures are nominal.

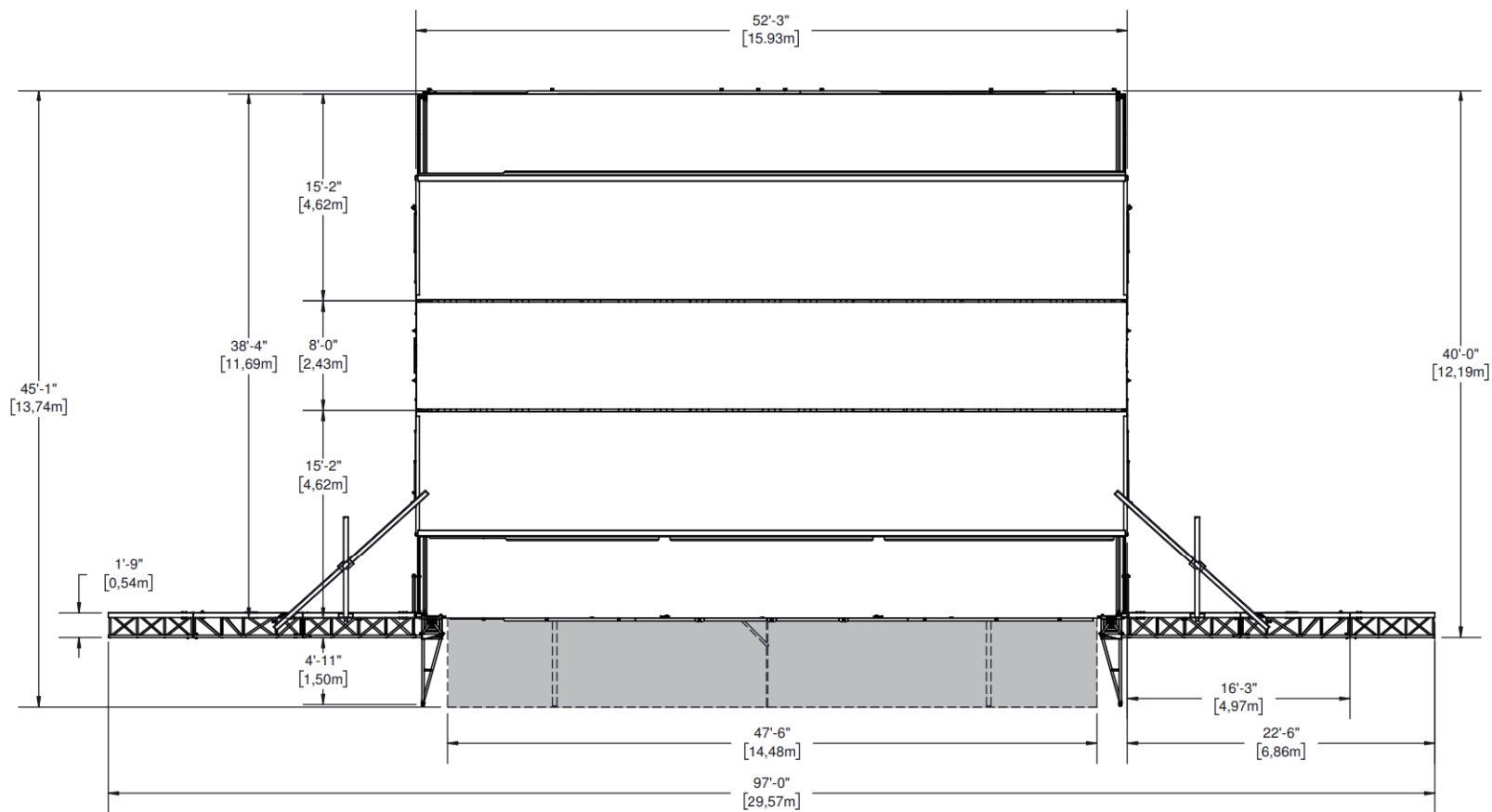

WINDWALL

Drawings may show stage equipped with optional accessories. May be sold separately.

© 2022 - All rights reserved, Stageline Mobile Stage Inc. Any and all forms of adaptation or reproduction of this document including the plans and drawings, in whole or in part, are strictly forbidden without the written authorisation of Stageline Mobile Stage Inc. Mass may vary depending on options. Technical specifications may change without notice. Stage specifications are subject to change without notice. Figures are nominal.

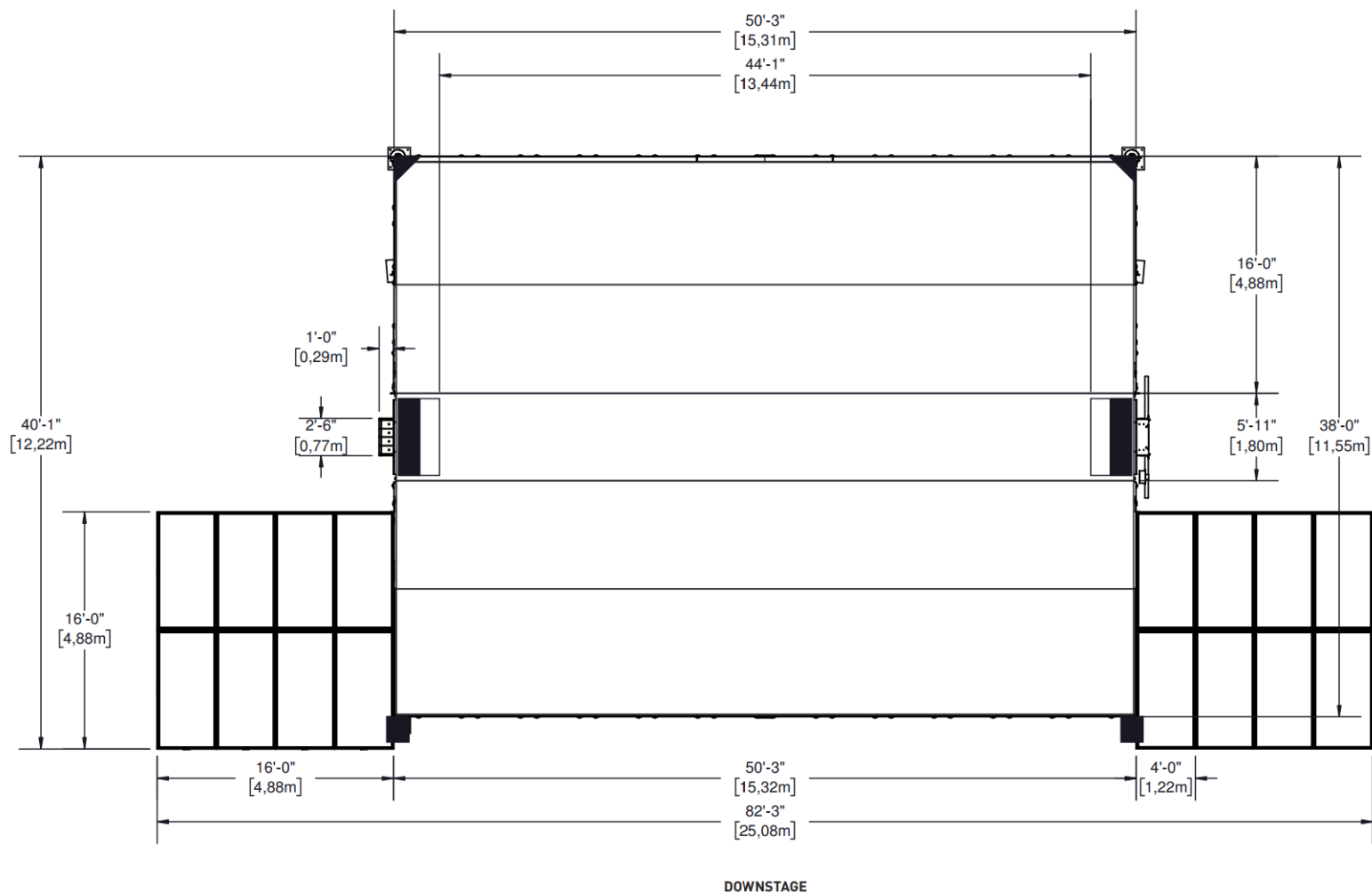

CAPACITY: 150lbs/ft² [732kg/m²]

Drawings may show stage equipped with optional accessories. May be sold separately.

© 2022 - All rights reserved, Stageline Mobile Stage Inc. Any and all forms of adaptation or reproduction of this document including the plans and drawings, in whole or in part, are strictly forbidden without the written authorisation of Stageline Mobile Stage Inc. Mass may vary depending on options. Technical specifications may change without notice. Stage specifications are subject to change without notice. Figures are nominal.

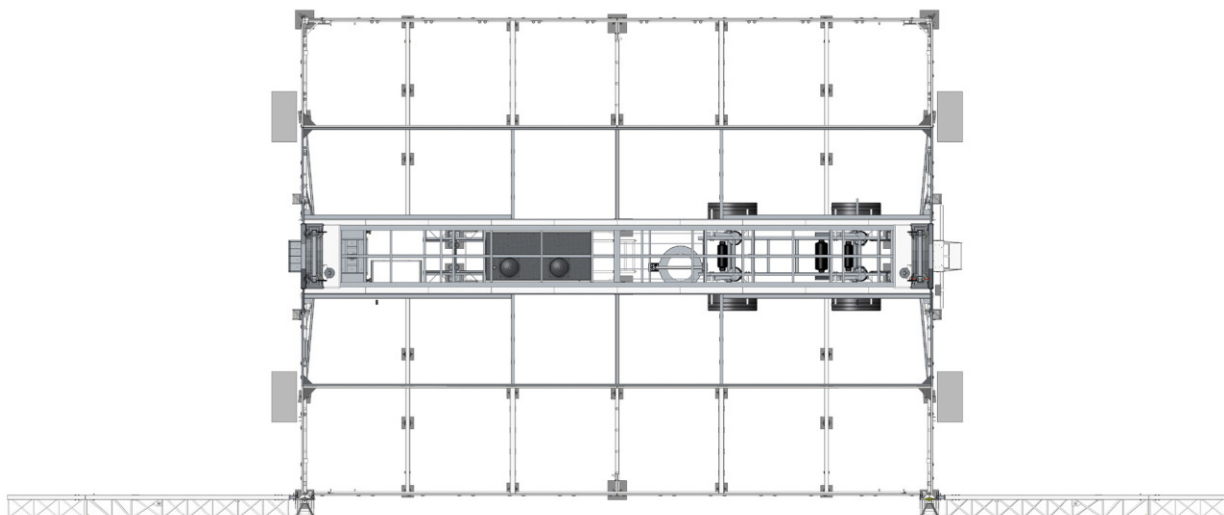

Screens or banners with an effective surface of more than 128 ft<sup>2</sup> (11.90 m<sup>2</sup>) and less than 300 ft<sup>2</sup> (27.87 m<sup>2</sup>).

Stage ballasts are mandatory and must be installed at locations shown.

Each ballast must have a minimum weight of 2000 lb (907 kg).

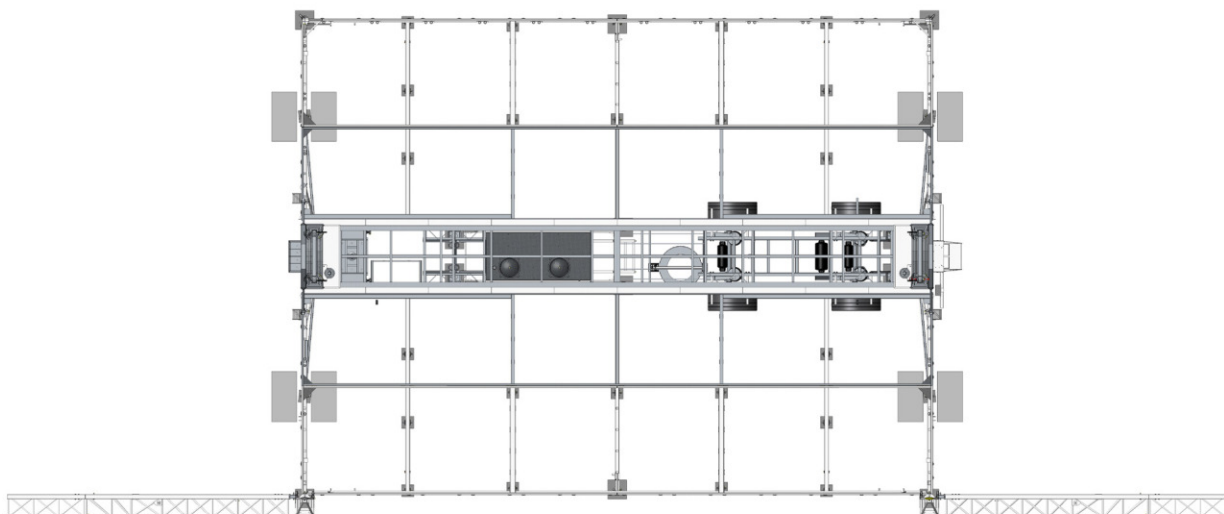

Screens or banners with an effective surface of more than 300 ft<sup>2</sup> (27.87 m<sup>2</sup>).

Maximum screen or banner dimensions (W x H) are 22 ft x 32 ft (6.71m x 9.75m)

Stage ballasts are mandatory and must be installed at locations shown.

Each ballast must have a minimum weight of 2000 lb (907 kg).

BALLAST

Drawings may show stage equipped with optional accessories. May be sold separately.

© 2022 - All rights reserved, Stageline Mobile Stage Inc. Any and all forms of adaptation or reproduction of this document including the plans and drawings, in whole or in part, are strictly forbidden without the written authorisation of Stageline Mobile Stage Inc. Mass may vary depending on options. Technical specifications may change without notice. Stage specifications are subject to change without notice. Figures are nominal.

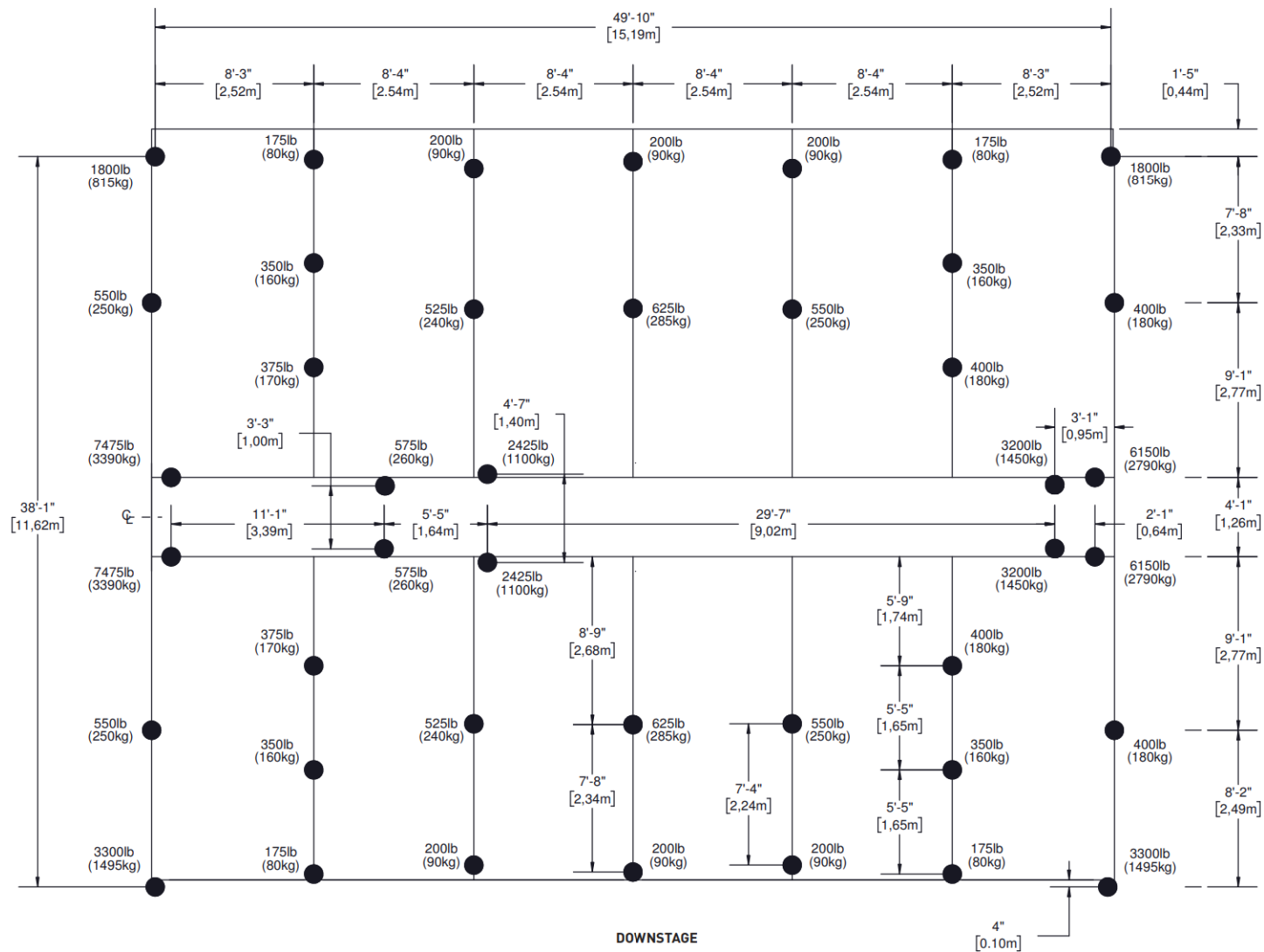

● FLOOR STABILIZERS, EXTENSIONS AND LEVELLING JACKS

Drawings may show stage equipped with optional accessories. May be sold separately.

© 2022 - All rights reserved, Stageline Mobile Stage Inc. Any and all forms of adaptation or reproduction of this document including the plans and drawings, in whole or in part, are strictly forbidden without the written authorisation of Stageline Mobile Stage Inc. Mass may vary depending on options. Technical specifications may change without notice. Stage specifications are subject to change without notice. Figures are nominal.

### Standard Configurations

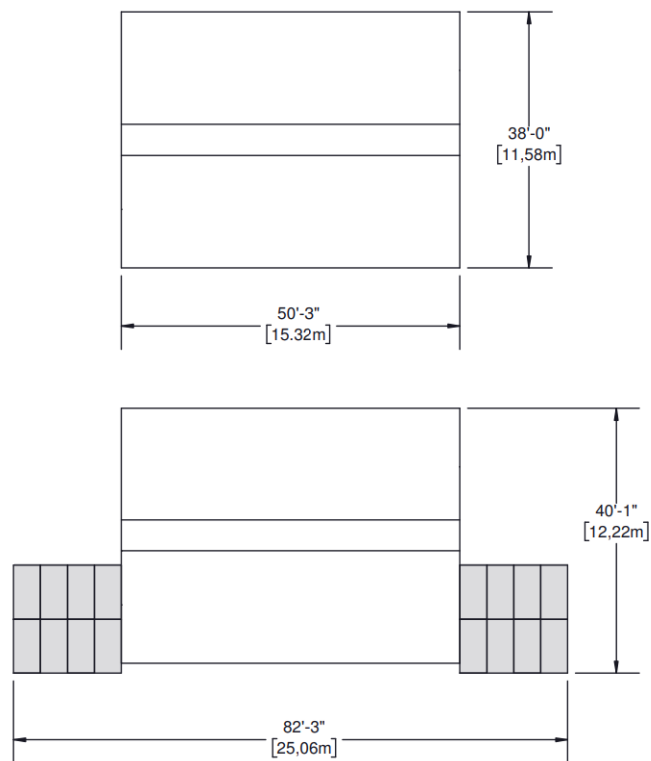

PLATFORM

Drawings may show stage equipped with optional accessories. May be sold separately.

© 2022 - All rights reserved, Stageline Mobile Stage Inc. Any and all forms of adaptation or reproduction of this document including the plans and drawings, in whole or in part, are strictly forbidden without the written authorisation of Stageline Mobile Stage Inc. Mass may vary depending on options. Technical specifications may change without notice. Stage specifications are subject to change without notice. Figures are nominal.

**A THOROUGH UNDERSTANDING OF THE INTER-RELATED LOADINGS SHOWN IN THIS RIGGING PLAN IS NEEDED IN ORDER TO SAFELY USE THIS MOBILE STAGE ROOF AND TAKE FULL ADVANTAGE OF THE MANY RIGGING OPPORTUNITIES IT OFFERS.**

This mobile stage roof offers a variety of rigging options with regard to load capacity, placement and type.

There are rigging pipes, trusses, roof rigging points and side overhang rigging beams.

This rigging plan locates and defines these rigging features, includes load capacity for each and describes maximum combinations of loads amongst features.

Take note of exclusions, maximum sub-totals in a group, load balance requirements, maximum lifting capacity of roof and maximum rigging load on roof.

The maximum load on the roof is less than the sum of the maximum load on each rigging feature.

**Refer to Operator's Manual for procedures in regards to proper setup and setup methods of the stage and its options.**

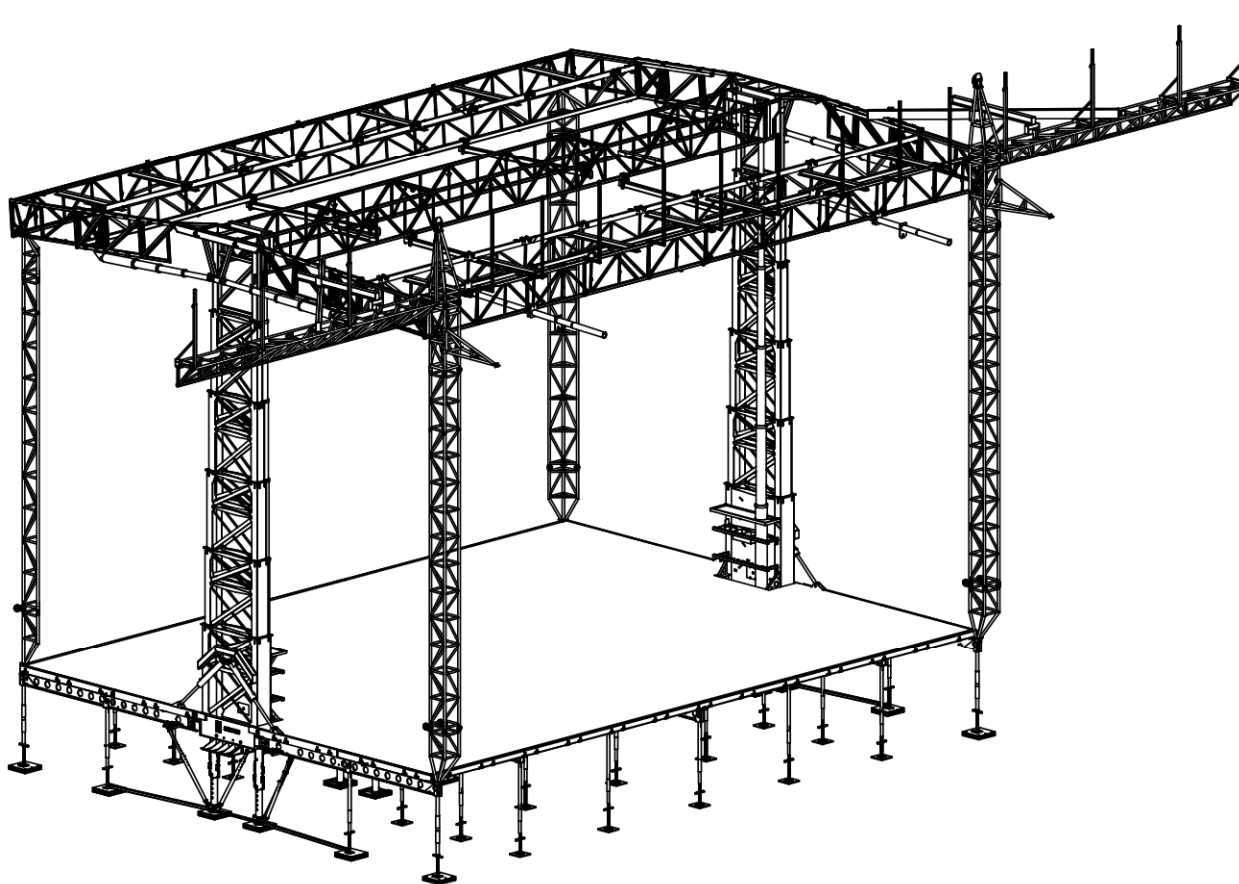

The information contained in the current document is final and must be considered as such. They are derived from design briefs and summarized to help the user plan rigging configurations safely. It is therefore mandatory that the user follows and respects the capabilities and limitations described herein. Overloading of stage components above their specified capacity may result in structural failure, equipment damage, injury or death. Stageline cannot be held responsible if the user, himself or subcontractors under his supervision, derogate from this document and/or the approved rigging plan. If a desired configuration cannot meet these requirements, the user must contact Stageline to analyse the case and obtain further instructions. Special restrictions and limitations may apply.

Certain authorities may require that a rig configuration plan, signed and sealed by a recognized member of a professional body, be available to allow the stage to be setup on their territory. This document was not intended to and cannot be used or considered as an official document or certificate to serve this purpose. Contact responsible authorities or Stageline for details.

**Drawings may show stage equipped with optional accessories. May be sold separately.**

© 2022 - All rights reserved, Stageline Mobile Stage Inc. Any and all forms of adaptation or reproduction of this document including the plans and drawings, in whole or in part, are strictly forbidden without the written authorisation of Stageline Mobile Stage Inc. Mass may vary depending on options. Technical specifications may change without notice. Stage specifications are subject to change without notice. Figures are nominal.

### RIGGING RESTRICTIONS:

- MAXIMUM LOAD BEARING CAPACITY: 42 000 lb (19 048 kg). All corner posts must be installed and pinned, and telescopic columns pinned and secured.
- The sum of all rigging points shown in area "A" of both sides of roof cannot exceed 9000 lb (4 082 kg).
- Total load on P8s must not exceed 8000 lb (3 629 kg) on each side.
- Total load on downstage T3 and P6s must not exceed 4000 lb (1814 kg).
- Total load on P9 and P10 must not exceed 4000 lb (1814 kg) per side.
- Capacity of side overhang truss must take into account the redistribution of weight from the P9 and P10 points.
- Total loads on P8\* shall not exceed 2000 lb (907 kg) per side.
- Loads on P11 points must be considered as a load on their respective adjoining truss(es) points.

### LIFTING RESTRICTIONS

- MAXIMUM LIFTING CAPACITY IS 4000 lb (1814 kg).
- Maximum asymmetric load difference between front and rear of stage is 2000 lb (910 kg). This includes loads on T1 trusses.
- Load must be symmetrically distributed between right and left side of stage.

### NOTES:

- Line array can be positioned at 2' (0.61 m), 4' (1.22 m), or at 6' (1.83 m) from roof extension panel.
- Movable beams must be attached to truss rigging points.

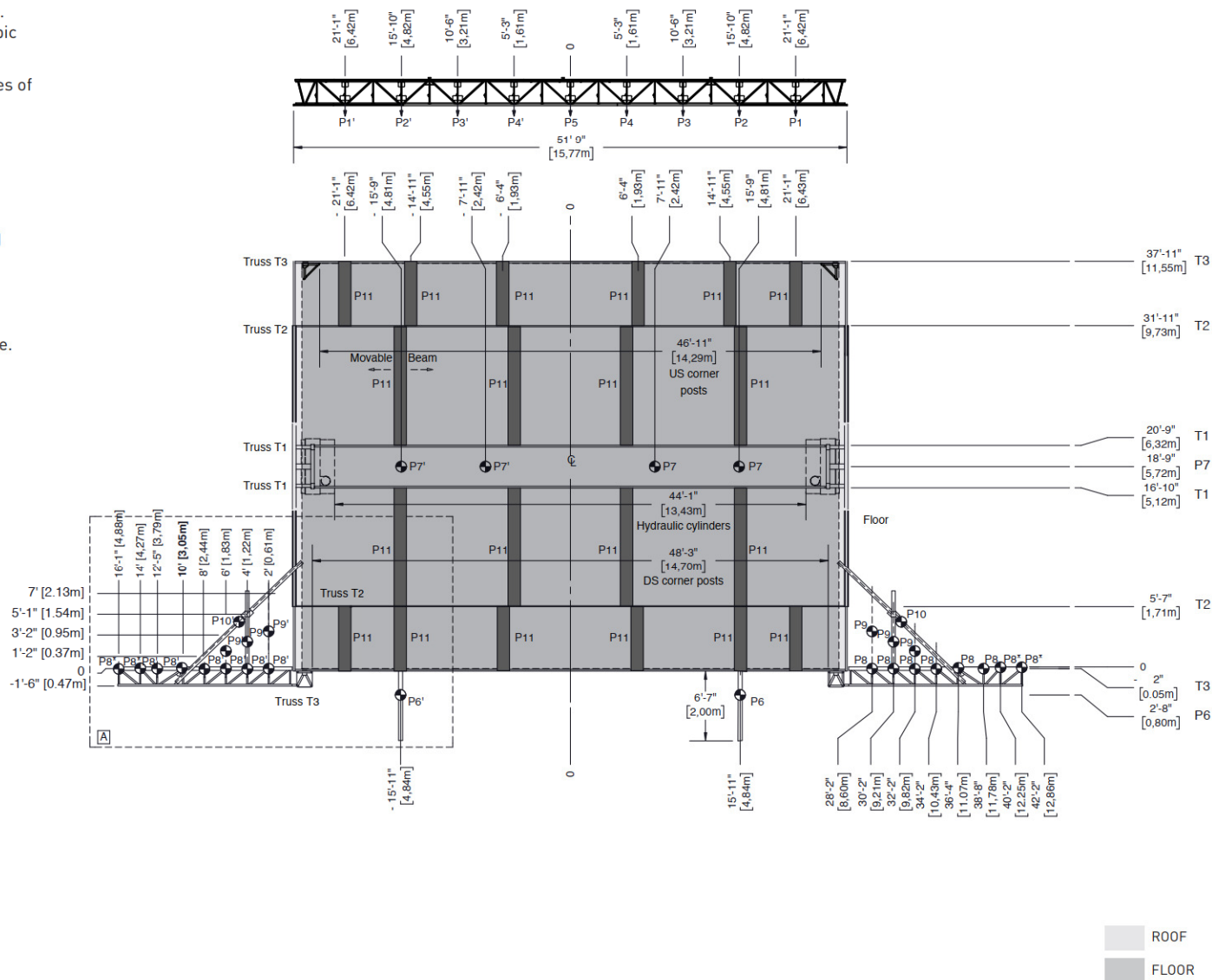

Drawings may show stage equipped with optional accessories. May be sold separately.

© 2022 - All rights reserved, Stageline Mobile Stage Inc. Any and all forms of adaptation or reproduction of this document including the plans and drawings, in whole or in part, are strictly forbidden without the written authorisation of Stageline Mobile Stage Inc. Mass may vary depending on options. Technical specifications may change without notice. Stage specifications are subject to change without notice. Figures are nominal.

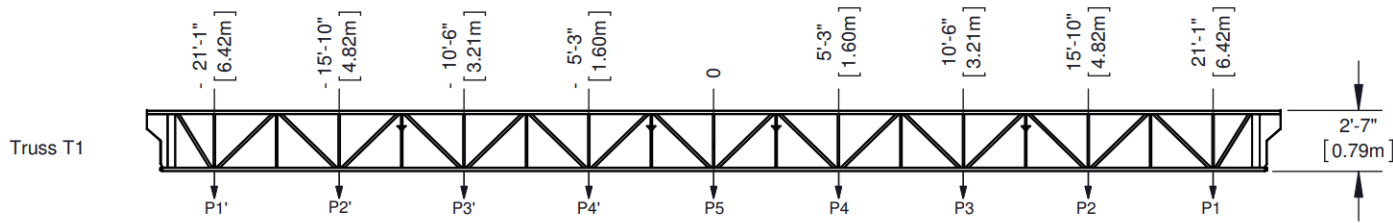

$$\text{Truss T1**}: \frac{\text{Load P1}}{\text{Capacity P1}} + \frac{\text{Load P2}}{\text{Capacity P2}} + \frac{\text{Load P3}}{\text{Capacity P3}} + \frac{\text{Load P4}}{\text{Capacity P4}} + \frac{\text{Load P5}}{\text{Capacity P5}} \leq 1.00$$

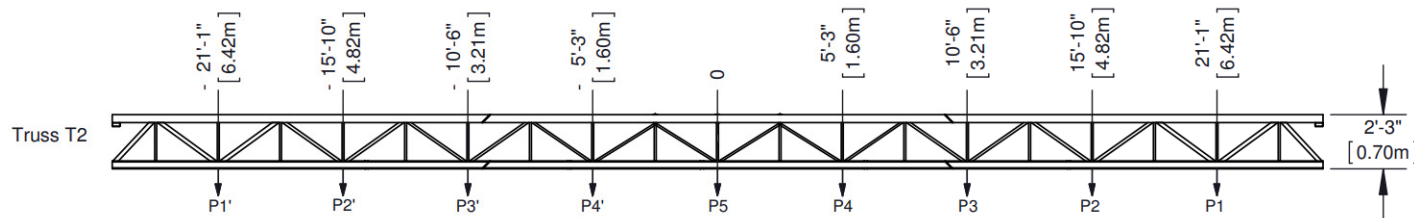

$$\text{Truss T2**}: \frac{\text{Load P1}}{\text{Capacity P1}} + \frac{\text{Load P2}}{\text{Capacity P2}} + \frac{\text{Load P3}}{\text{Capacity P3}} + \frac{\text{Load P4}}{\text{Capacity P4}} + \frac{\text{Load P5}}{\text{Capacity P5}} \leq 1.00$$

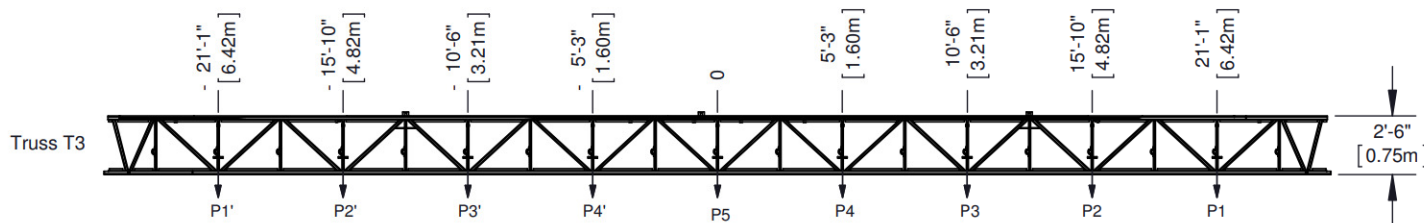

$$\text{Truss T3**}: \frac{\text{Load P1}}{\text{Capacity P1}} + \frac{\text{Load P2}}{\text{Capacity P2}} + \frac{\text{Load P3}}{\text{Capacity P3}} + \frac{\text{Load P4}}{\text{Capacity P4}} + \frac{\text{Load P5}}{\text{Capacity P5}} \leq 1.00$$

MAXIMUM LOAD CAPACITY		
Point No.	Lbs	Kg
P1, P2	2000	910
P3	1500	680
P4	1000	455
P5	1500	680
P6	1000	455
P7, P8	2000	910
P9 & P10	4000	1815
P11	2000	910

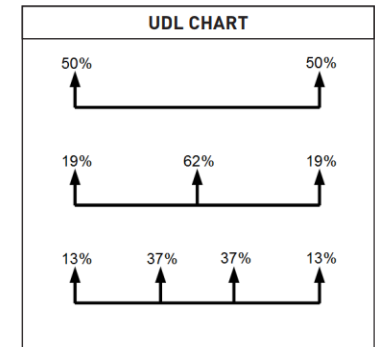

\*\* Valid for symmetric loads only. In other cases, contact Stageline for assistance.

Drawings may show stage equipped with optional accessories. May be sold separately.

© 2022 - All rights reserved, Stageline Mobile Stage Inc. Any and all forms of adaptation or reproduction of this document including the plans and drawings, in whole or in part, are strictly forbidden without the written authorisation of Stageline Mobile Stage Inc. Mass may vary depending on options. Technical specifications may change without notice. Stage specifications are subject to change without notice. Figures are nominal.

### WHEN CALCULATING THE LOAD ON A SAM555 TRUSS, USE FOLLOWING METHOD.

Each truss in the roof must be visualized as 2 trusses put together that share a center point.

**Examples:** Truss T2 on a SAM555.

Points from left to right are P1', P2', P3', P4', P5, P4, P3, P2, P1. We will only verify loads on 1 side of the truss, Meaning P1 thru P5.

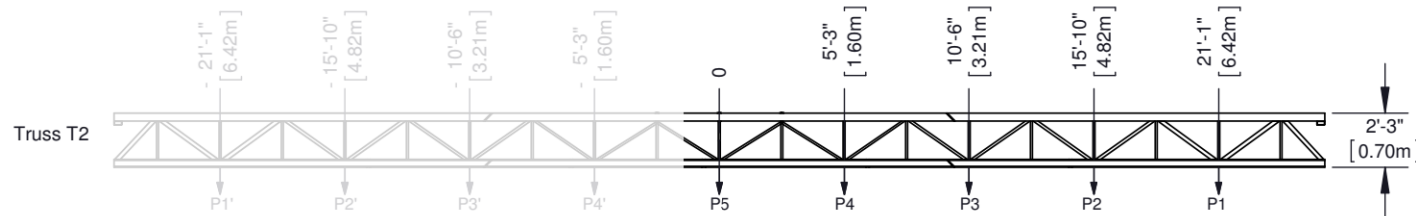

#### CALCULATION EXAMPLE #1:

1 lighting truss on 2 motors, total uniformly distributed weight of the truss is 3000lbs.

Each motor will be hung from the P1 points.

- $0.50 \times 3000$  (50% of weight, see UDL chart) / 2000 (the capacity of the P1 on the T2 truss) = 0.75.
- $0.75 = 75\%$ , as 1.00 would equal 100%.

**So the T2 truss is at 75% of its total capacity.**

#### CALCULATION EXAMPLE #2:

1 lighting truss on 3 motors, total uniformly distributed weight of the truss is 3000lbs.

The motors will be hung from P1', P5, P1.

- **P1**  
 $0.19 \times 3000$  (19% of weight, see UDL chart) / 2000 (capacity P1) = 0.29, so this one point will use 29% of the truss capacity.
- **P5**  
 $0.62 \times 3000$  (62% of weight, see UDL chart) / 1500 (capacity P5) = 1.24.

Now that we have the loads for both points, we add them together to determine the total load on the truss.

$$0.29 + 1.24 = 1.53$$

**So the T2 truss is at 153% of its total capacity.**

#### CALCULATION EXAMPLE #3:

1 lighting truss on 4 motors, total uniformly distributed weight of the truss is 3000lbs. The motors will be hung from P1', P3', P3 and P1.

- **P1**  
 $0.13 \times 3000$  (13% of weight, see UDL chart) / 2000 (capacity P1) = 0.19, so this one point will use 19% of the truss capacity.
- **P3**  
 $0.37 \times 3000$  (37% of weight, see UDL chart) / 1500 (capacity P3) = 0.74.

Now that we have the loads for both points, we add them together to determine the total load on the truss.

$$0.19 + 0.74 = 0.935$$

**So the T2 truss is at 93.5% of its total capacity.**

### WHEN CALCULATING THE LOAD ON A SAM555 TRUSS, USE FOLLOWING METHOD.

Each truss in the roof must be visualized as 2 trusses put together that share a center point.

**Examples:** Trusses T2 and T3 on a SAM555.

Points from left to right are P1', P2', P3', P4', P5, P4, P3, P2, P1. We will only verify loads on 1 side of the truss, Meaning P1 thru P5.

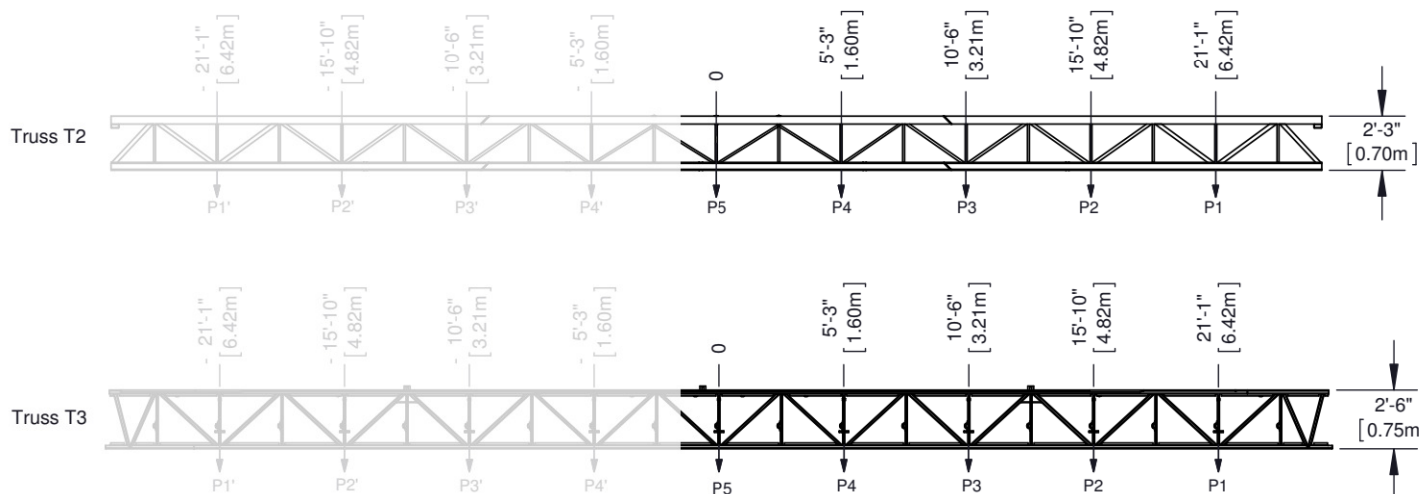

### CALCULATION EXAMPLE #4:

1 screen on 4 motors, total uniformly distributed weight of the screen is 3200lbs. The motors will be hung 4' from the upstage T3 truss, on P11 points (movable beams), at P1', P4', P4 and P1.

#### - Weight distribution on trusses

T2 truss = 4' (distance from T3 truss) / 6' (distance between T2 and T3 trusses) = 0.67, so 67% of the weight from each motor will be distributed to the T2 truss,

T3 truss = 2' (distance from T2 truss) / 6' (distance between T2 and T3 trusses) = 0.33, so 33% of the weight will be distributed to the T3 truss.

#### - T2, P1

$0.13 \times 3200$  (13% of weight, see UDL chart)  $\times 0.67$  (weight transfer on T2) / 2000 (capacity P1) = 0.14, so this one point will use 14 % of the truss capacity.

#### - T2, P4

$0.37 \times 3200$  (37% of weight, see UDL chart)  $\times 0.67$  (weight transfer on T2) / 1000 (capacity P4) = 0.79.

Now that we have the loads for both points, we add them together to determine the total load on the T2 truss.

$$0.14 + 0.79 = 0.93$$

**So the T2 truss is at 93% of its total capacity.**

#### - T3, P1

$0.13 \times 3200$  (13% of weight, see UDL chart)  $\times 0.33$  (weight transfer on T3) / 2000 (capacity P1) = 0.07, so this one point will use 7% of the truss capacity.

#### - T3, P4

$0.37 \times 3200$  (37% of weight, see UDL chart)  $\times 0.33$  (weight transfer on T3) / 1000 (capacity P4) = 0.39.

Now that we have the loads for both points, we add them together to determine the total load on the T3 truss.

$$0.07 + 0.39 = 0.46$$

**So the T3 truss is at 46% of its total capacity.**

#### - P11 @ P1

$0.13 \times 3200$  (13% of weight, see UDL chart) / 2000 (capacity P11) = 0.21, so this one point will use 21% of the beam capacity.

#### - P11 @ P4

$0.37 \times 3200$  (37% of weight, see UDL chart) / 2000 (capacity P11) = 0.59, so this one point will use 59% of the beam capacity.

**So none of the points on the P11s exceed the movable beams capacity.**